

# signkit

BANNERS

BESPOKE SIGNAGE

CABLE 1.5 MM + 3 MM

FIRE ESCAPE SIGNS

LUMOS

PANEL SUPPORTS

PICTOGRAM + DISC

POINT OF SALE

ROD 6 MM + 12 MM

SIGNBLOCK + XBLOCK

SIGNSLOT

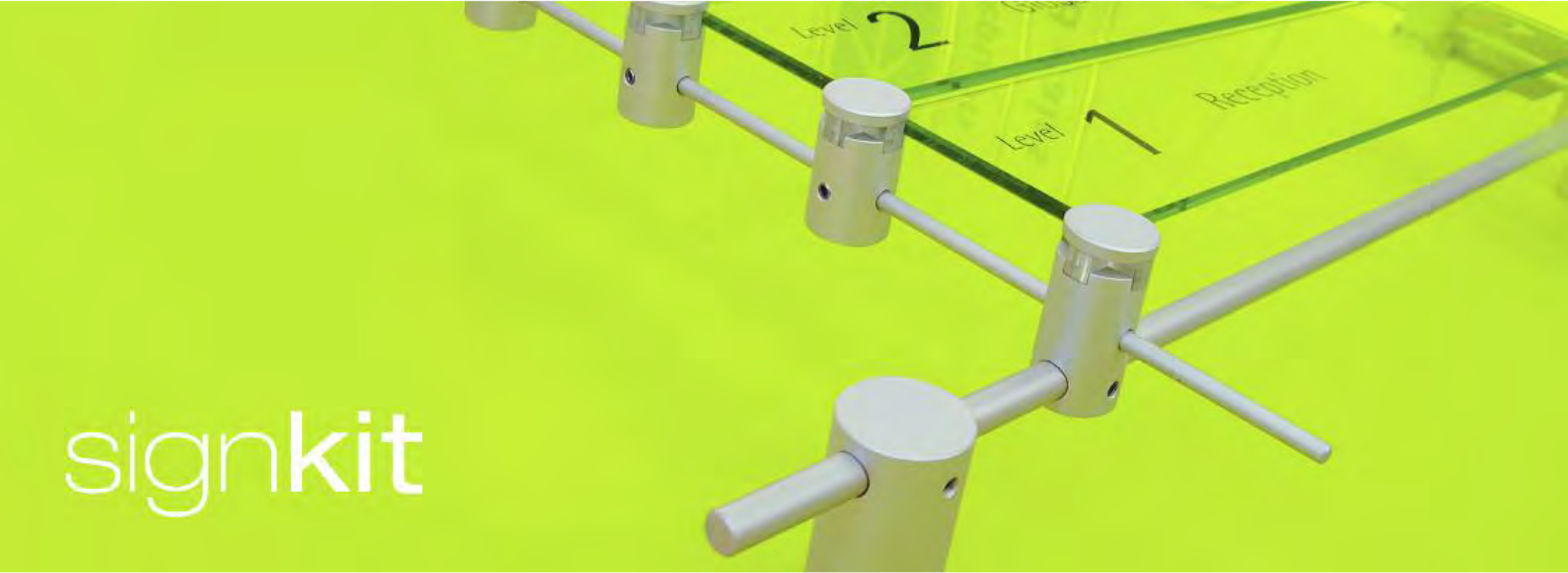

siggr

ankit

# 99 Bishopsgate

Floor	Company Name
20th Floor	Latham & Watkins
19th Floor	Latham & Watkins
18th Floor	Latham & Watkins
17th Floor	Latham & Watkins
16th Floor	Latham & Watkins
15th Floor	Latham & Watkins
14th Floor	Deutsche Bank
13th Floor	Deutsche Bank
12th Floor	Deutsche Bank
11th Floor	Deutsche Bank
10th Floor	Deutsche Bank
9th Floor	Deutsche Bank
8th Floor	Deutsche Bank
7th Floor	Deutsche Bank
6th Floor	Deutsche Bank
5th Floor	Deutsche Bank
4th Floor	Deutsche Bank
3rd Floor	Deutsche Bank
2nd Floor	Deutsche Bank
1st Floor	Deutsche Bank
Basement	Universities Superannuation Scheme Building Management Base





Signkit is a complete system of precision engineered components for the display of signs and media. Designed with the versatility to provide simple but effective signs.

This fully integrated sign system creates unique architectural signage with an edge, designed to interface with a wide range of materials including toughened glass, acrylic, composites or timber.

# Contents

- 02** Rod 6mm + 12mm
- 06** Cable 1.5mm + 3mm
- 08** Bespoke Signage
- 12** Signblock + Xblock
- 16** Signslot
- 18** Panel Supports
- 20** Project Lumos
- 22** Lumos Square
- 24** Fire Escape Signs
- 25** Illuminated Fire Escape Signs
- 26** Point of Sale
- 27** Banners
- 28** Project Pictogram
- 29** Disc

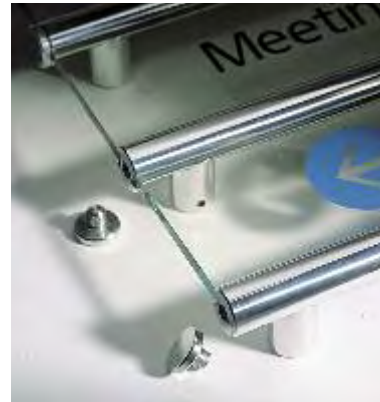

## Rod 6mm + 12mm

The Rod system allows the ability to construct reception directory signs over 4m high. Rod can be fixed wall to wall or floor to ceiling and the range of components allow for vertical and horizontal configurations as well as grid arrangements using crossover connectors.

This is a highly adaptable, flexible and immensely strong system for the display of graphic panels manufactured from any substrate. The system is available in silver satin anodised aluminium, black satin anodised aluminium, stainless steel or brass finishes.



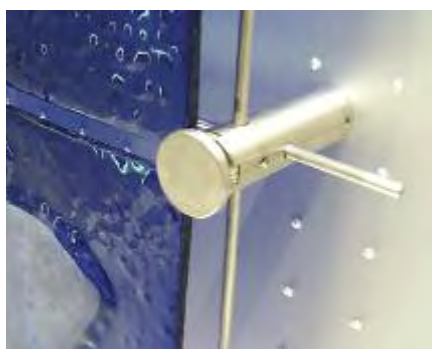

**Rod A.**  
40mm Ø, wall mount to hold 12mm rod

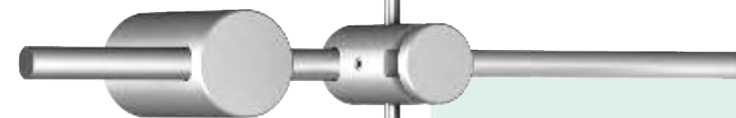

**Rod B.**  
30mm Ø cross over fixing for 6mm Ø vertical & 12mm Ø horizontal rod

**Rod C.**  
30mm Ø panel fixing for 6mm vertical rod



**Rod D.**  
30mm Ø wall mounted panel fixing for 6mm vertical rod. Used as additional wall support every 750mm



**Rod E.**  
30mm Ø wall mounted cross over fixing for 6mm Ø vertical and 12mm Ø horizontal rod

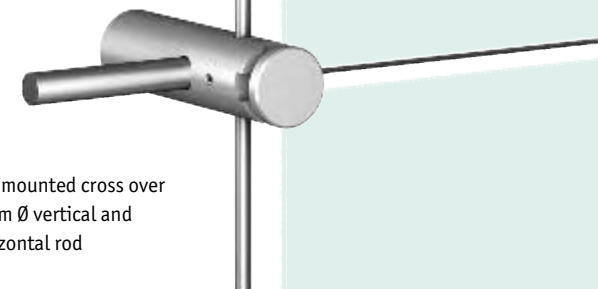



This contemporary sign support system empathises with both traditional and modern architecture alike.

## Rod 6mm + 12mm

Here are just a few of the many different components within the Signkit range to fix signage panels to both 6mm and 12mm Ø systems.

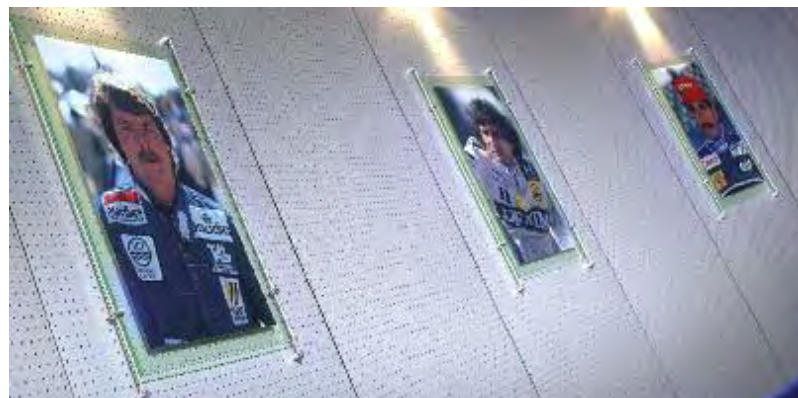

**R.6(6)**  
2 piece panel grip,  
holds panels up  
to 10mm thick

**R.15(6)**  
Panel support, holds  
drilled panels  
up to 10mm thick

**R.11(6)**  
2 piece picture hook,  
holds panels up  
to 10mm thick

**R.17**  
Top edge grip,  
holds panels up  
to 10mm thick

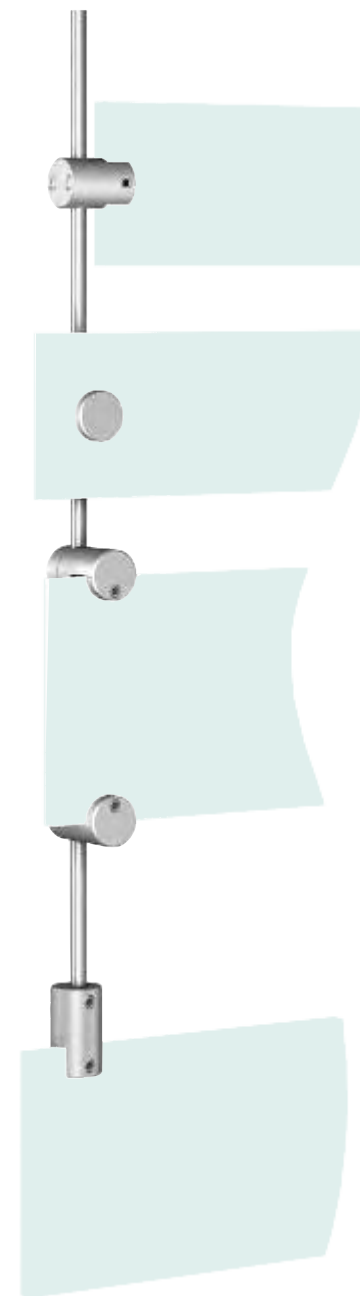

## Cable 1.5mm + 3mm

The Signkit cable components range is available for use with both 1.5mm & 3mm cable as standard and includes cable fixings to suit different weights of signage as well as all site requirements – including wall to wall, ceiling or wall to floor, or just ceiling mounted and the cables can be specified with low voltage lighting for illuminated displays.

Tensioned cable components are perfectly suited for supporting wayfinding signs throughout a building as they provide the flexibility of changing the number of listings or layout order at just the turn of a grub screw.

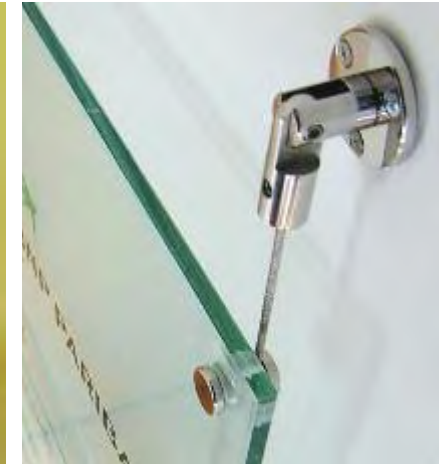
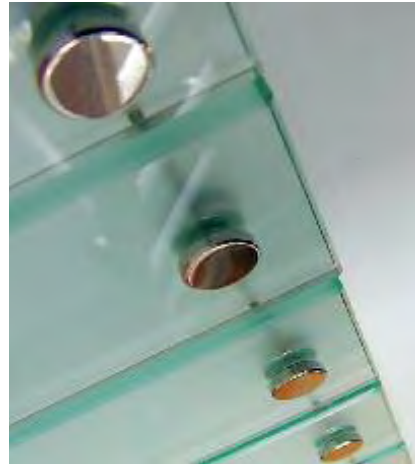



All components are available in satin anodised aluminium, black anodised aluminium, stainless steel or brass finishes and as individual components or as complete cable kits. Here are just a few of the many different components within the Signkit range to fix signage panels to cable.

**15.3**  
Fixing plate

**15.4**  
End stop

**15.14**  
Double sided panel grip, holds panels up to 10mm thick

**15.13**  
Single sided panel grip, holds panels up to 10mm thick

**15.23**  
Panel support, holds drilled panels up to 10mm thick

**15.5**  
Cable tensioner

**15.3**  
Fixing plate

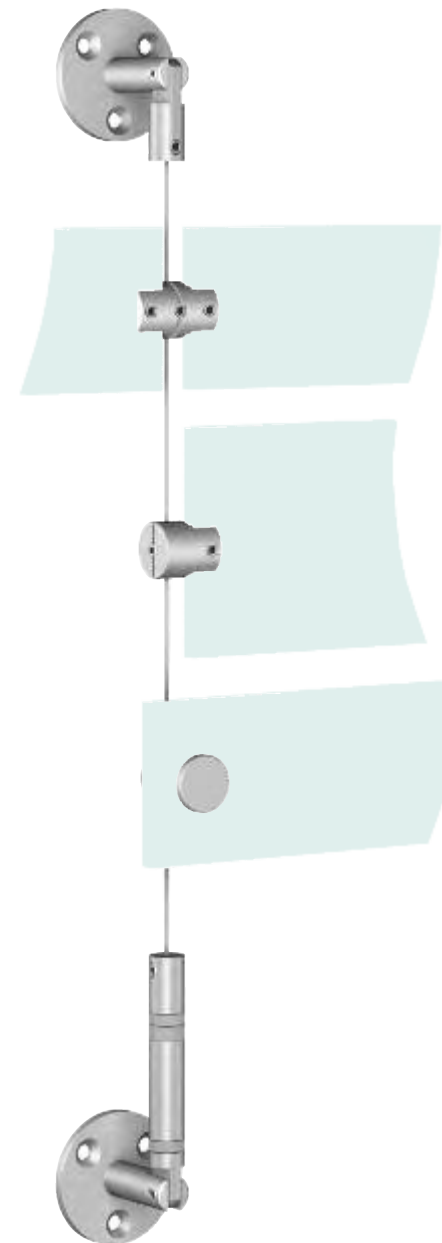

# Bespoke Signage

With full in-house production facilities, we have the capability to respond to diverse requirements and deadlines whilst maintaining complete control of costs and quality. At Signkit we pride ourselves on being able to offer a bespoke service that is genuinely second to none and we relish the opportunity to tackle any project, large or small, corporate or leisure.





# Bespoke Signage

From initial contact to project completion, our design service and technical expertise is an invaluable resource for our customers. We offer the same care for a one-off sign or a complete wayfinding or statutory sign programme, that includes full drawings, supply and installation.

Visitors to our showroom are encouraged to discuss their requirements with one of our design team who are on hand to give technical advice on the suitability of particular materials.





Signkit can also create a wide variety of outside pylons for signage which can be configured to suit your requirements. Here are some examples incorporating different shaped profiles and finishes, as well as single and double sided versions and with different fixing options.

# Signblock + Xblock

Signblock is sleek and minimal in design and its flexibility of application allows it to be specified to provide a secure fixing method for all types of signs and notices.

Signblock's clean purity of line creates simple uninterrupted shapes for a contemporary look and a functional form that pleases the eye. These sleek contours are achieved by being cleverly supported by concealed brass olives, locating on a grub screw.

Signblock can also be specified with LED illumination to edge-light acrylic or glass panels, making it suitable to be specified for Fire Escape signage.

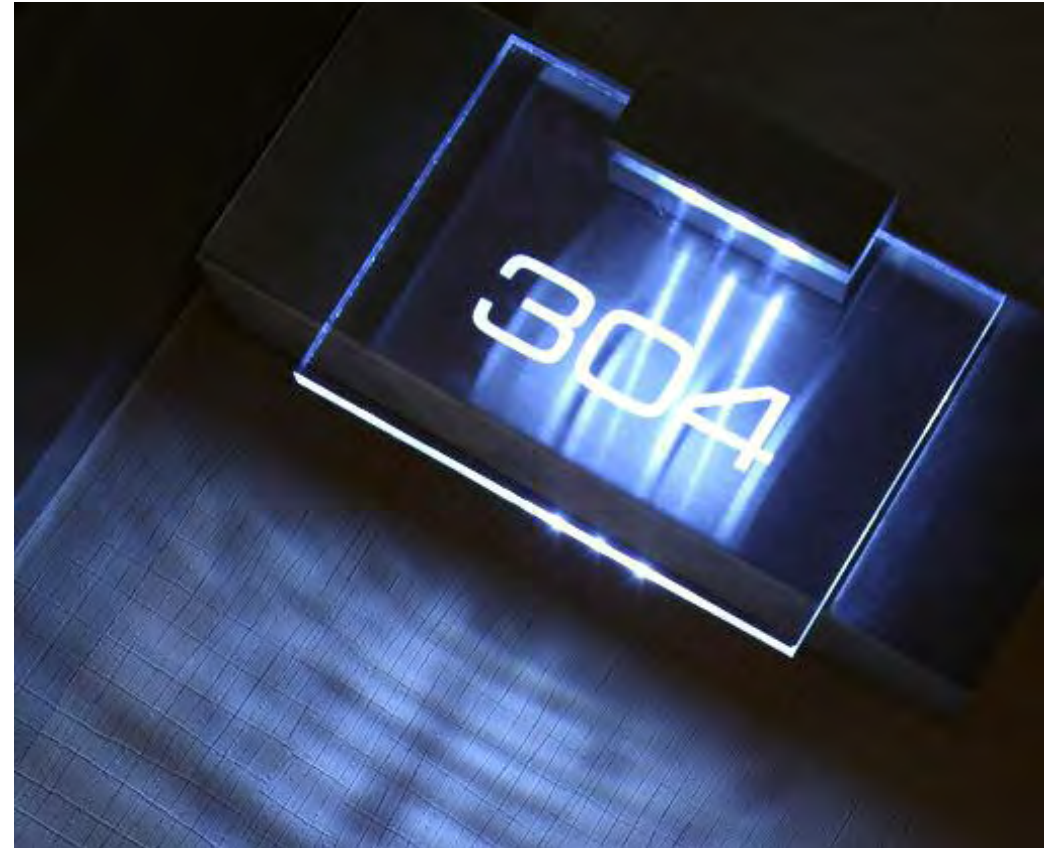



**Signblock ceiling mounted**



**Signblock wall mounted**

Signblock is available in wall, projecting and ceiling mounted versions, is supported by concealed brass olives and can be used to support signs from top, bottom and side edges.

# Signblock

Signblock is machined from 25mm square sections of aluminium, stainless steel or brass and is available in any length up to 1500mm and slot sizes can be specified to accommodate panel thickness of 2-10mm. And it can be supplied in wall mounted, projecting, suspended, freestanding or as desk top signage versions.



# Xblock

As part of the Signblock range, Xblock is another sleek, stylish and cost effective way to wall mount signs and acrylic image/poster holders. It is machined with a standard slot to accommodate panels of up to 8mm thick and is available in silver satin anodised finish in lengths of up to 1500mm.

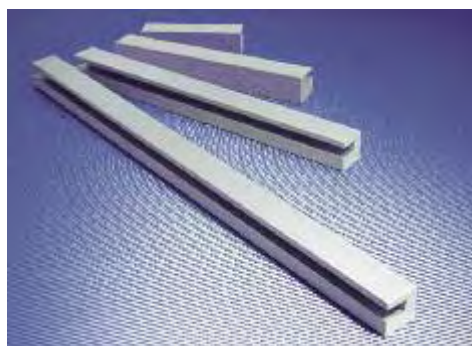

# Signslot

The slender, refined lines of Signslot enhance any ceiling suspended or wall mounted signs from department identification to a retail or tenant directory. Signslot can accept panels from 2-10mm, which are secured in position with concealed grub screws and is precision engineered in 3 diameters, Micro - 12mm Ø, Mini - 19mm Ø and Maxi - 30mm Ø.

Signslot is available in any length up to 1500mm, with either a single or double slot, in silver satin anodised aluminium, black satin anodised aluminium, stainless steel or brass finishes.

Signslot can be wall mounted with a 25mm stand off or rod suspended with 100mm drop rods as standard. Or a 1.5mm cable fixed option is available with adjustable cable drops, which is recommended for variable ceiling heights.



**Micro Signslot** in 12mm diameter takes panels up to 2mm thick and may be top or side fixed



**Mini Signslot** in 19mm diameter takes panels between 3 to 6mm thick and may be top or side fixed



**Maxi Signslot** in 30mm diameter takes panels between 8 to 10mm thick and may be top or side fixed

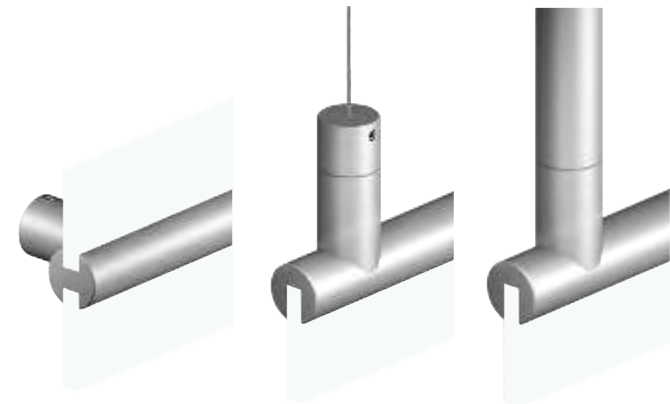

Signslot can be wall mounted and can hold two panels, as shown here

Signslot can also be ceiling mounted with either fixed rods at a standard or custom-made length. Or by 1.5mm diameter stainless steel cables cut to any length.

# Panel Supports

For drilled and edge fixed panels

These panel supports provide an easy method to mount signs and nameplates and can hold a variety of materials including glass, mirror, acrylic, timber, stone and metal up to 25mm thick. They are strong, functional, well made and elegant fixings, that will enhance any display from temporary exhibition to internal or external permanent signage and the range includes versions for drilled and edge fixed panels.

There are three different fixing options available for most of these supports and the standard fixing disc for drilled panels can be replaced by a vandal proof fixing using a countersunk allen screw - please call for details.

Panel supports are available in satin or black anodised aluminium, bright polished, brushed stainless or machine finished stainless steel and brass.

Components from our standard range are instantly available - with specials of any size and material manufactured with a very quick turnaround.



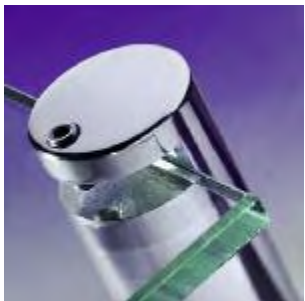

## 15.35 Drilled panel supports

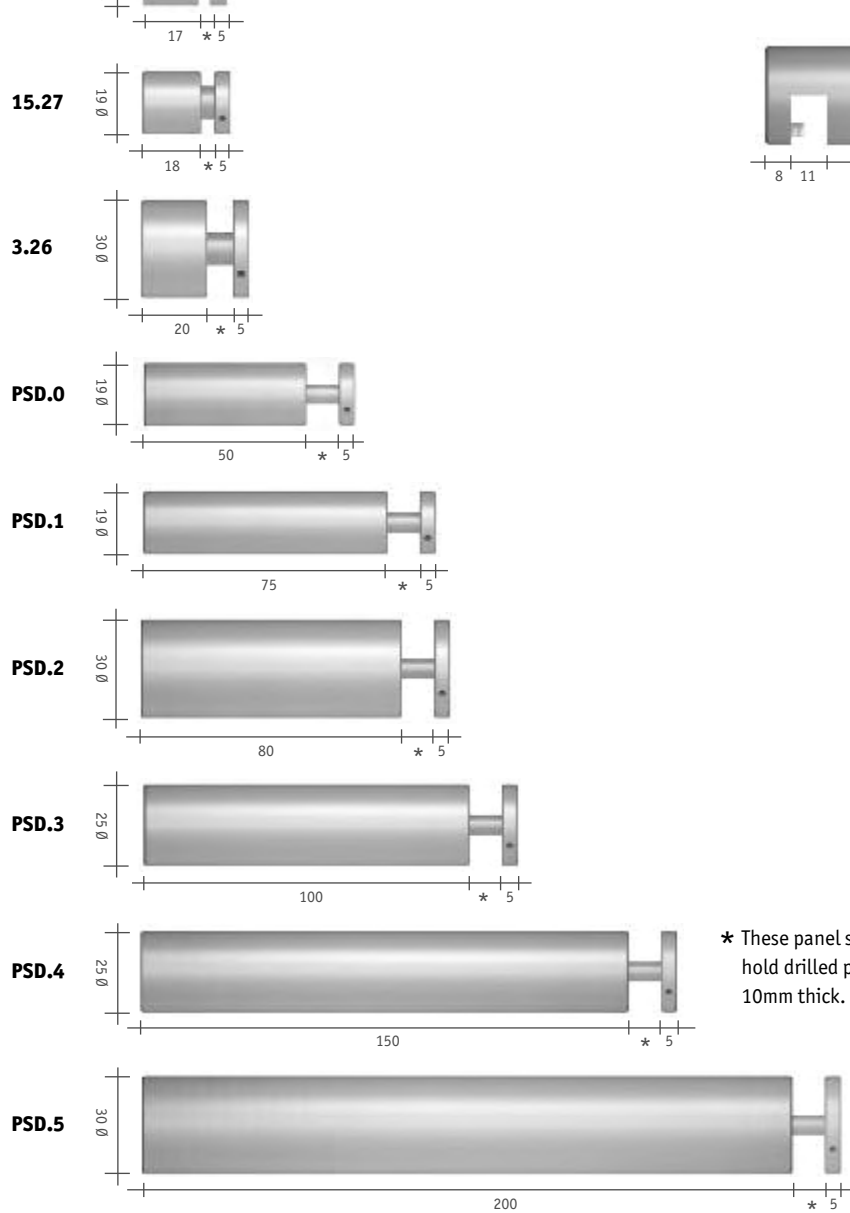

## Edge fixed panel supports

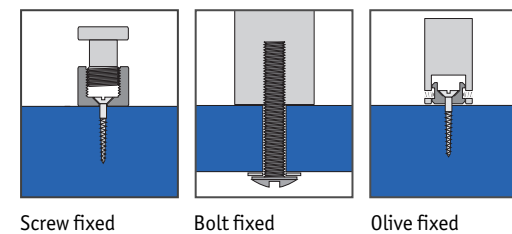
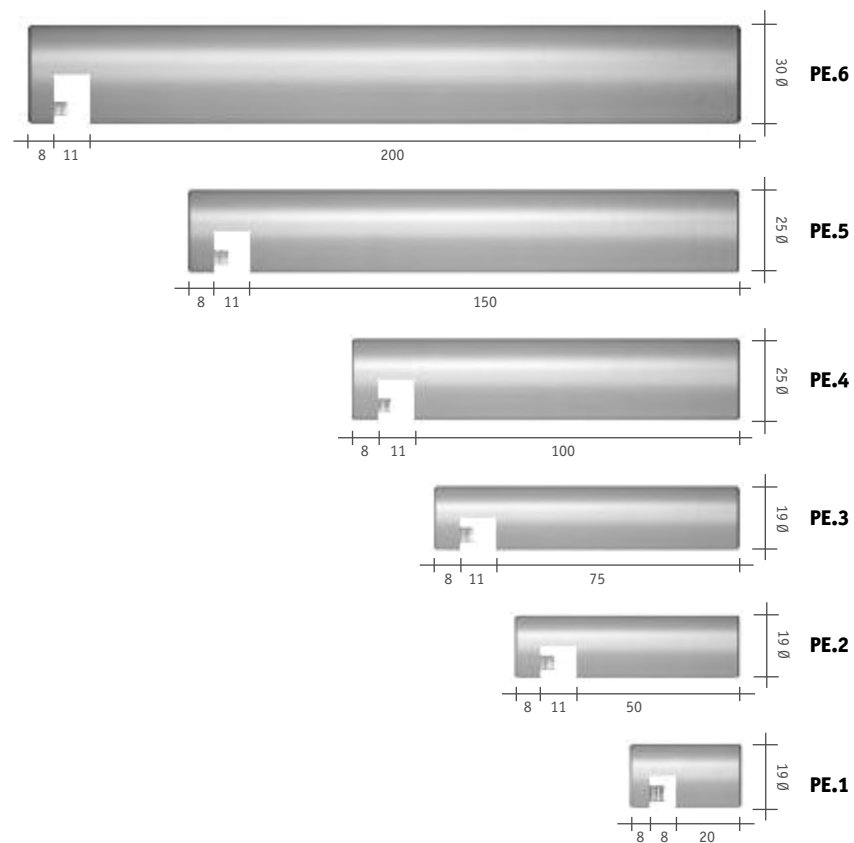

Three different fixing options are available for most of these panel supports - please call for details.

# Project Lumos

Market research shows illuminated signs have 30% more impact than non-illuminated signs and Project Lumos is an easy way to create that high impact illuminated signage with a 'fit and forget' device that is incredibly energy efficient.

Using the latest solid state technology, this patented fixing has been specifically designed to support and edge illuminate glass or acrylic panels. When light passes through either material and meets the laser engraved or sandblasted graphics they are brilliantly illuminated.

Project lumos is available in a vivid range of LED colours that are incredibly energy efficient, with a rated life of some 50,000 hours the 1W Luxeon LEDs, which are 'fit & forget' devices. Operating on low voltage DC, the electronic driver can be positioned up to 4 metres from the fitting or concealed behind the sign in an accessible location. Project Lumos spaces panels 20mm from the fixing plain, is machined from 40mm diameter stainless steel with either a polished or satin finish and can be used both internally and externally. When RGB switchable LED are specified - it is now possible to illuminate room signs to show the occupancy status. UK Patent GB2403335.





40mm Ø panel support to accept 5-10mm glass or acrylic. 1W LED with rated life of 50,000 hours available in a range of colours. Up to 8 Lumos fixings can be connected in series to an electronic driver, which must be positioned in an accessible location no more than 4m from the LED.

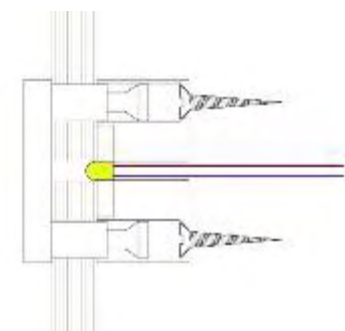

We recommend using Opti-white low iron glass. Text and graphics can be either sandblasted, laser engraved or decorated with 3M vinyls to the rear of the panel. Panels require drilling with 3 No 9mm Ø holes. Drilling templates are available on request.

# Lumos Square

Lumos Square is similar to the round Project Lumos but provides a 40mm square wall fixing, only 35mm deep, to support and edge illuminate glass or acrylic panels. As with Project Lumos, when light passes through either material and meets the laser engraved or sandblasted graphics the effect is quite simply, illuminating. Lumos Square is available in a vivid range of LED colours that are incredibly energy efficient. With a rated life of some 50,000 hours the 1W Luxeon LEDs are 'fit & forget' devices. Operating on low voltage DC, the electronic driver can be positioned up to 4 metres from the fitting or concealed behind the sign in an accessible location. Lumos Square is available in a satin anodised aluminium finish. With an RGB switchable LED, it is now possible to illuminate room signs to show the occupancy status. To signal the room is engaged, a red LED can be switched to green when vacant and blue to signal room service. UK Patent GB2403335.



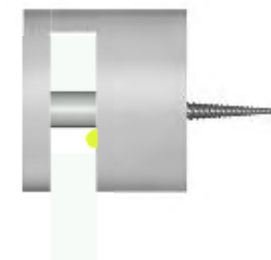
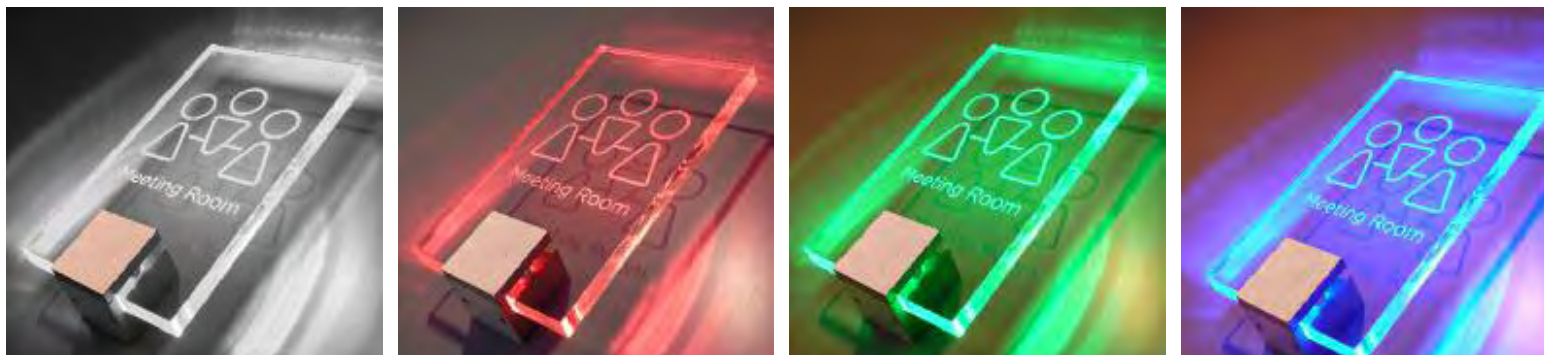

40mm sq panel support to accept 10mm glass or acrylic. 1W LED with rated life of 50,000 hours available in a range of colours. Up to 8 Lumos fixings can be connected in series to an electronic driver, which must be positioned in an accessible location no more than 4m from the LED.

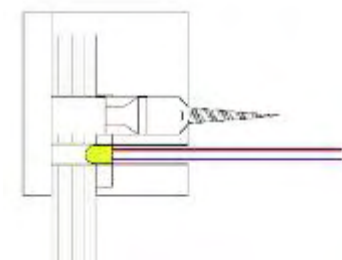

We recommend using Opti-white low iron glass. Text and graphics can be either sandblasted, laser engraved or decorated with 3M vinyls to the rear of the panel. Panels require drilling with 3 No 9mm Ø holes. Drilling templates are available on request.

## Fire Escape Signs

Signkit provides a range of fixing solutions for wall mounted, suspended and projecting fire escape signs to suit any budget or requirement. Signkit FE is a quality collection of fire signs complying to current legislation and are available in two basic designs conforming to either BS 5499-4:2000 or EC Directive 92/58/EEC. Manufactured from acrylic, Foam PVC or aluminium panels with screen printed, laser engraved or vinyl graphics, there is a Signkit component to suit every application.

Photoluminescent vinyls can be specified for non-electrical signs incorporating phosphors that, if excited by UV or visible radiation, store energy, which is emitted as light over a period of time.



**XBlock FE** - Ceiling or wall mounted panels supported with SAA Xblock fixing.



**Project FE** - Wall mounted panels supported with SAA Micro Project fixings.



**Cable FE** - Ceiling mounted panels supported with SAA cable fixings, adjustable to suit on site.



**Drop Rod FE** - Ceiling mounted panels supported with 19mm Ø SAA 100mm long drop rod fixings.



**Signslot FE** - Ceiling or wall mounted panels supported with SAA Micro or Mini signslot fixing.

# Illuminated Fire Escape Signs

The Signkit FE LED illuminated emergency fire exit sign is incredibly energy efficient. With a rated life of some 50,000 hours the high performance LED's are 'fit & forget' devices. Operating on low voltage DC, the electronic driver can be positioned up to 4 metres from the fitting or concealed behind the sign in an accessible location.

Signblock FE and Signslot FE have a satin anodised aluminium finish and are available in two standard sizes - 480mm x 160mm or 300mm x 100mm with laser engraved graphics. Complete with either a maintained or non-maintained LED unit with a minimum 3 hour battery back up.

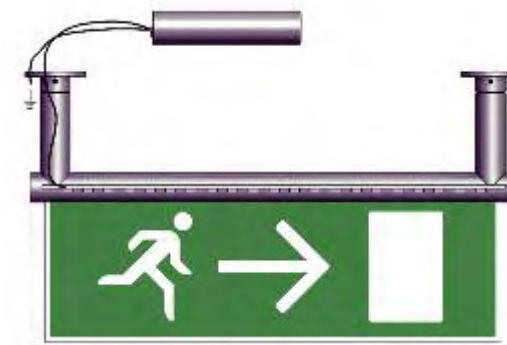

## Signslot FE LED Illuminated

SAA signslot LED illuminated fire exit sign comprising 10mm thick laser engraved acrylic panel 480mm x 160mm. Ceiling suspended or wall mounted in 30mm Ø signslot with either 100mm long drop rods or 40mm stand-off bracket. Supplied with either a maintained or non-maintained LED driver and battery back up to provide a minimum 3 hours emergency illumination in the event of mains power failure.

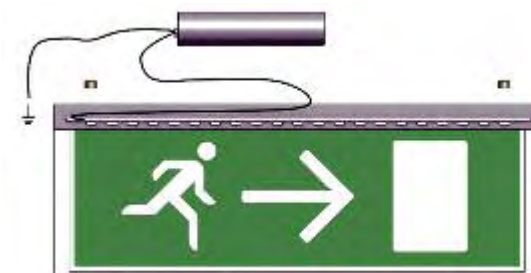
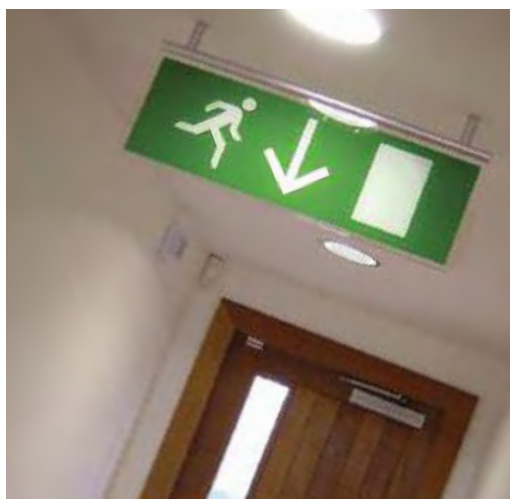

## Signblock FE LED Illuminated

SAA signblock LED illuminated fire exit sign comprising 10mm thick laser engraved acrylic panels in two standard sizes, 480mm x 160mm & 300mm x 100mm. Ceiling suspended or wall mounted in 25mm square signblock for flush fixing to ceiling or wall. Supplied with either a maintained or non-maintained LED driver and battery back up to provide a minimum 3 hours emergency illumination in the event of mains power failure.

# Point of sale

Internal, freestanding

Signkit provides a varied range of display and point of sale solutions including single and double sided freestanding banners, brochure and poster holders to compliment the other systems within the Signkit range.

Virtually any requirement can be met by utilising existing solutions from within the Signkit range or by bespoke production. Here are just a few examples of Signkit's point of sale items, please call the design/sales team for further details of what is available.

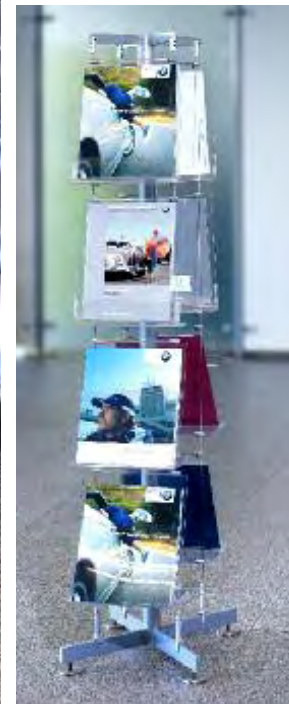
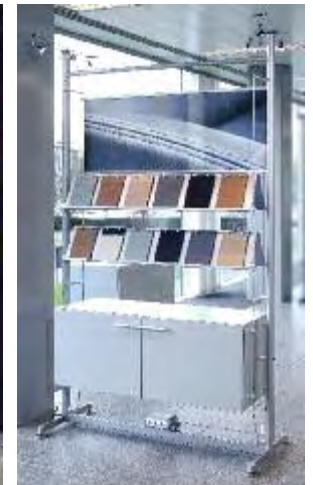
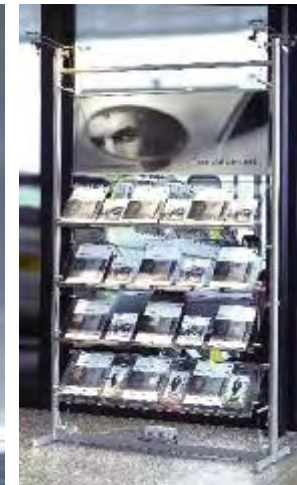
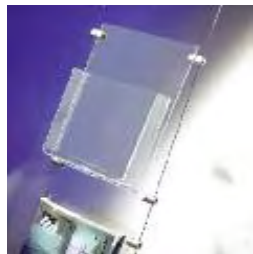

# Banners

Internal and external, fixed

Signkit can produce a wide variety of banners for both internal and external use, in many different styles, materials and fixing methods. Both simple and complex configurations can be achieved through Signkit's standard and custom made components and when specified for internal use they can incorporate low-voltage lighting, as illustrated here.

Please feel free to contact our design/sales department regarding any banner requirements as Signkit's many years of experience within this sector will prove invaluable to your project.

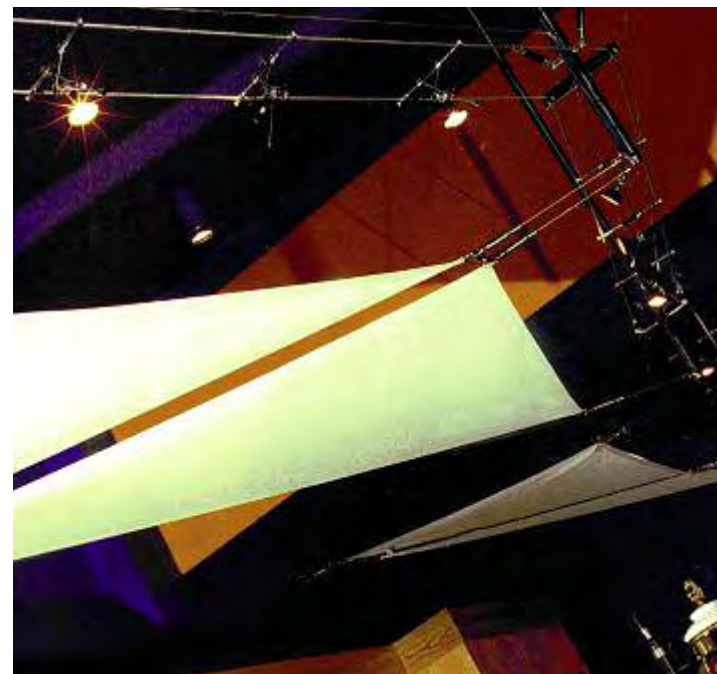
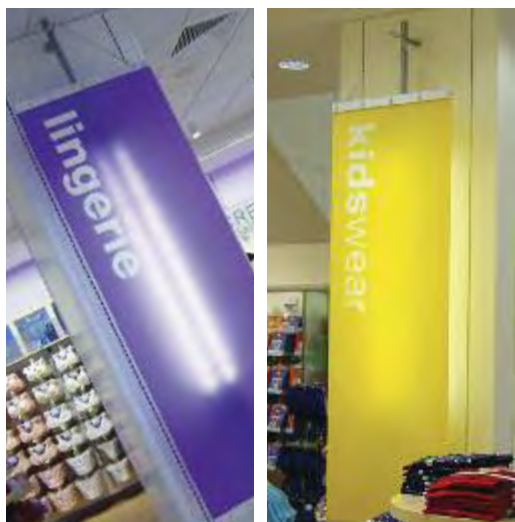

# Project Pictogram

Project Pictogram is an inspiring range of registered designs, presenting a new generation of contemporary off-the-shelf range of international symbols and safety signs, developed specifically for designers looking for something different.

These simple but modern universally recognisable designs are a chic and fresh alternative collection of symbols to suit any environment.

The signs are manufactured from either 140mm sq, or 100mm Ø 6mm thick silica acrylic, with reverse printed graphics on an etched disc and are supported with satin anodised micro project fixings as standard - with specials available, designed and produced to conform to any corporate identity upon request.

All Project pictograms signs are supplied complete with drilling guide and are also available with fixings manufactured in mirror or satin polished stainless steel or brass.

We have illustrated just some of the most popular designs however should you not see your requirement please do contact the sales team.



# Disc

Safety signs using graphical symbols provide important benefits in the field of communication. Used effectively they can provide information in a compact form that is independent of language, have visual impact and guide the viewer. Consistent application of safety signs can make a major contribution to good communication and the development of a best practice safety culture within an organisation. With laser engraved and screen printed graphics to safety colour specifications, Signkit discs comply to BS5499 and at 75mm the discs are fixed with 3M high bond adhesive tape or they can be specified with countersunk screws. The discs are manufactured in 1.5mm thick satin stainless steel as standard but are also available in mirror polished stainless steel and silver anodised aluminium on request.

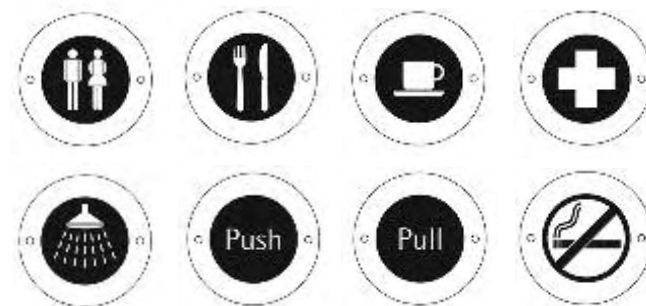
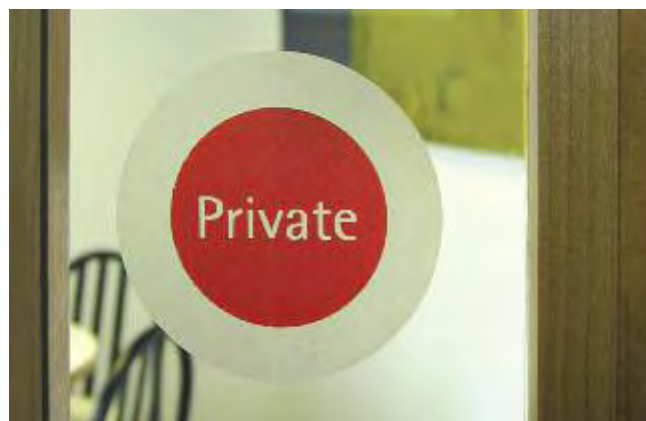

## Digital Disc

To complement the steel range we also produce digitally printed vinyl discs, particularly suited for glazed door applications. Digital discs are printed on self adhesive 3M dusted crystal.

As with Project Pictogram, we have only illustrated a few of the most popular designs so if you not see your requirement please do contact the sales team.

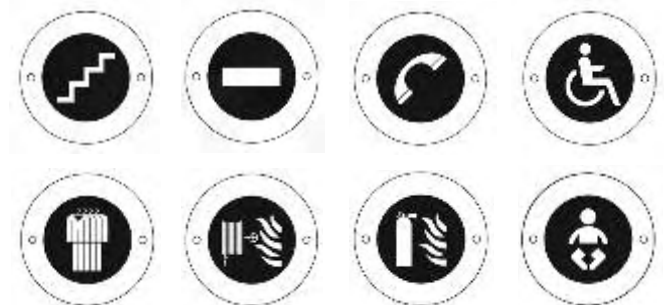

siggr

# shopkit

#### **SHOPKIT SPAIN**

Calle Luis de la Mata nº 14 D, OFIC 2  
Madrid 28042. Spain  
Tel: +34 91 300 57 20  
Fax: +34 91 300 57 21  
email: [info@shopkit.com.es](mailto:info@shopkit.com.es)

#### **SHOPKIT FRANCE**

Hubert II . 19, av. Georges Pompidou  
FR-40130 Capbreton . France  
Tel: +33 562 39 57 22  
Fax: +33 5 58 72 07 49  
email: [info@shopkit.fr](mailto:info@shopkit.fr)

#### **DESIGNPLUS**

P.O. Box 789 · Al Khobar · 31952  
Kingdom of Saudi-Arabia  
Tel: +966 (0)3 882 9252  
Fax: +966 (0)3 882 9251  
email: [info@designplus-sa.com](mailto:info@designplus-sa.com) web: [designplus-sa.com](http://designplus-sa.com)

#### **B&N INDUSTRIES**

1409 Chapin Ave . 2nd Floor . Burlingame  
California 94010 . U.S.A  
Tel: +1 800 350 4127  
Fax: +1 650 593 3112  
email: [info@bnind.com](mailto:info@bnind.com) web: [www.bnind.com](http://www.bnind.com)

#### **DAVIES GROUP**

Showroom No. 4 . Opp. Al Khaleej National School  
Al Garhoud . Dubai . UAE  
Tel: +9714 2828528  
Fax: +9714 2828328  
email: [info@daviesgroupuae.com](mailto:info@daviesgroupuae.com)

#### **LOGOGRAFICA INDUSTRIAL, LDA**

Rua C Lote 73-A . Vale do Forno  
2675 Odivelas . Portugal  
Tel: +35121 931 2061  
Fax: +35121 931 2045  
email: [geral@logografica.pt](mailto:geral@logografica.pt) web: [www.logografica.pt](http://www.logografica.pt)

signkit  
QUALITY  
PRECISION  
CREATIVITY  
FLEXIBILITY

**SHOPKIT GROUP LIMITED**

100 Cecil Street · North Watford · Hertfordshire WD24 5AD · England

Tel: +44 (0)1923 818282 Fax: +44 (0)1923 818280 email: [sales@shopkit.com](mailto:sales@shopkit.com) web: [www.shopkit.com](http://www.shopkit.com)

**SHOPKIT EXPORT LIMITED**

100 Cecil Street · North Watford · Hertfordshire WD24 5AD · England

Tel: +44 (0)1923 818282 Fax: +44 (0)1923 818280 email: [export@shopkit.com](mailto:export@shopkit.com) web: [www.shopkit.com](http://www.shopkit.com)

**SHOPKIT GmbH**

Adler Str. 9 · 40211 Düsseldorf · Germany

Fon: +49(0)211/38 69 6-0 Fax: +49(0)211/38 69 6-24 email: [info@shopkit.de](mailto:info@shopkit.de) web: [www.shopkit.de](http://www.shopkit.de)